

U 4.165

Ersatzteilliste
 Spare parts list
 Liste de pièces de rechange
 Listino pezzi di ricambio
 Lista de piezas de recambio
 Lista de peças sobresselentes
 Reserveonderdelenlijst
 Reservdelists
 Reservdelslista

SERVICE

BECKER
D-42279 Wuppertal
www.becker-international.com

year

No. **G**

type **U 4.165-XX**

frequency Hz

speed min⁻¹

power required kW

inlet capacity m³/h

pressure + mbar

vacuum - mbar

Made in Germany

Index Variante

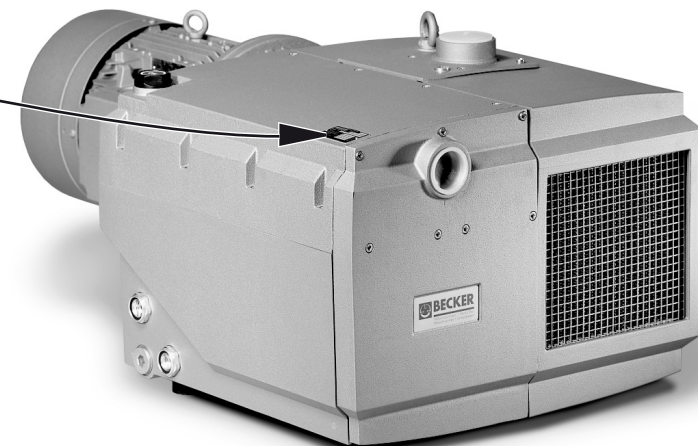

Reservdelslista
 Varaosaluettelo
 Wykaz części zamiennych
 Seznam náhradních dílů
 Tartalékalkatrész lista
 Κατάλογος ανταλλακτικών
 Yedek parça listesi
 Перечень запасных частей
 备用零件目录
 スペアパーツリスト

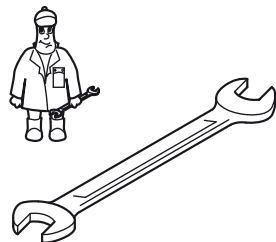
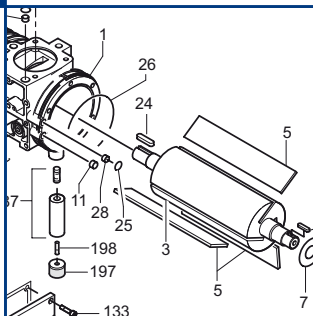

| Pos. | Menge ²⁾ Quantity Quantité Quantità Cantidad | Bestell-Nr. Ident No. No. Identification No. de pedido | Bezeichnung Description Designation Designazione Descripción |
|------|---|---|--|
| □ | 1 | 549000 26400 | Dichtungssatz, Complete set of seals, Jeu de joints, Kit di guarnizioni, Junta Completa |
| 5 | SATZ/KIT | 900505 00003 | Schieber, Rotor Vane, Palette, Empujador |
| 83 | 2 | 965415 00000 | Luftentölelement, Oil separating element, Element separation huile, Cartuccia sepa-ratore olio, Elemento de desaceitar de aire |

²⁾ erforderliche Bestellmenge / necessary order quantity / quantité nécessaire / quantità di ordinazione necessari / cantidad necesario

Wartung
 Maintenance
 Entretien
 Manutenzione
 Mantenimiento



U 4.165

Standard



Variante



U 4.165/XX

①
U 4.165 F/K

② ③
U 4.165 SA/K-25 + F/K-25

④ ⑤
U 4.165 SA/K-25.1 + F/K-25.1

⑥
U 4.165 SA/K-51 + F/K-51

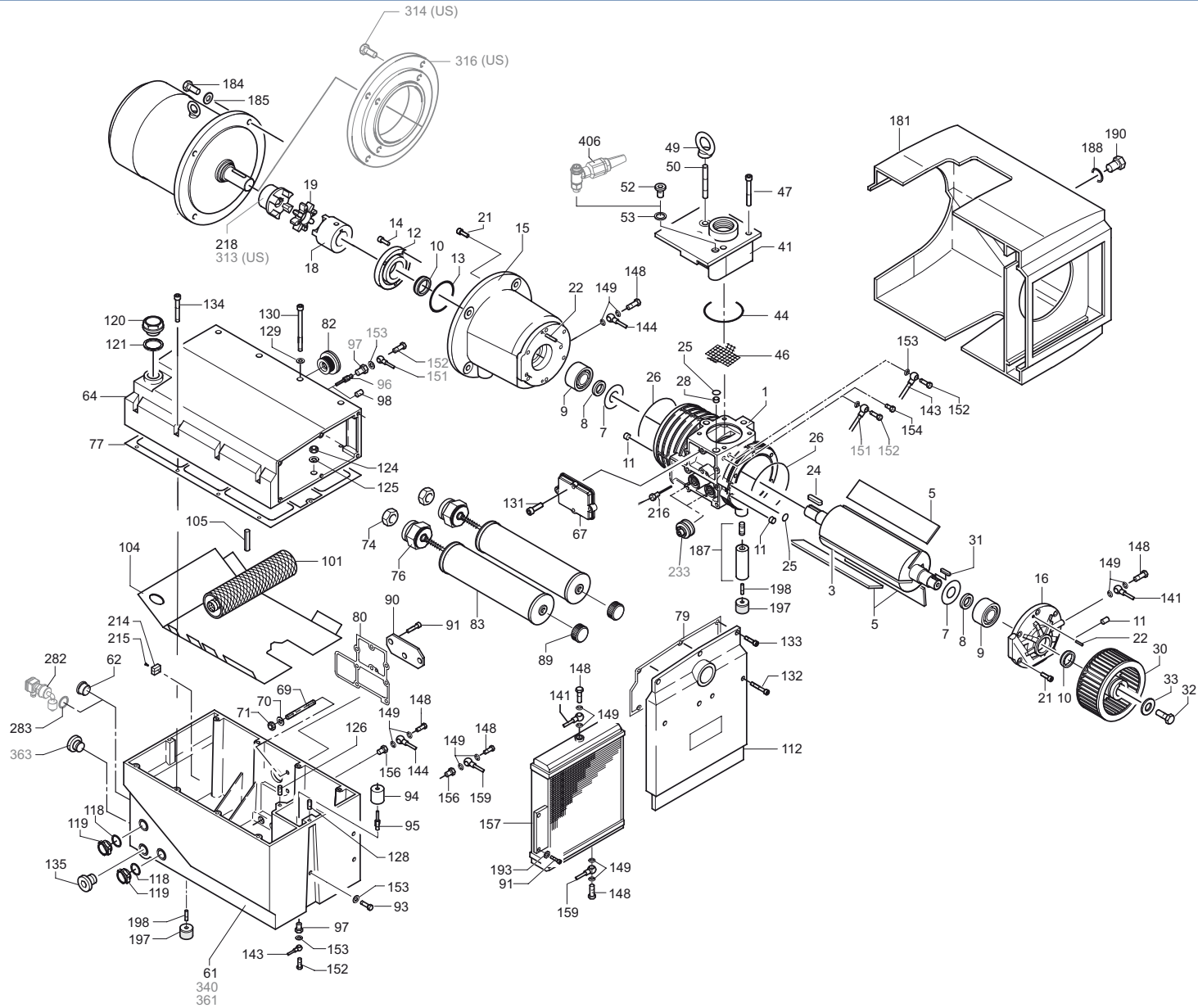

⑦
U 4.165 SA/K-54

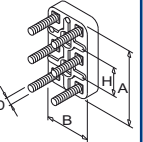
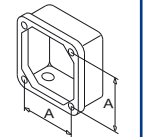
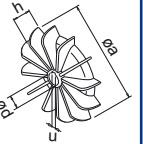
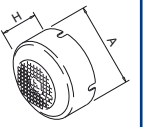
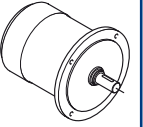

SERVICE ?





| G INDEX | Pos. | Bestell Nr. | Beschreibung |  |
|-------------------|--------------|--|--|---|
| U 4.165 | □ | 549000 26400 | DICHTUNGSSATZ ¹⁾ | |
| | 1 | 000102 26300 | GEHÄUSE | |
| | 3 | 020000 26300 | KOLBEN | |
| | 5 | 900505 00003 | SCHIEBER, KUNSTSTOFF (SATZ) ²⁾ | |
| | 7 | 917611 00000 | LAGERDICHTRING | |
| | 8 | 911472 00000 | DISTANZSCHEIBE | |
| | 9 | 906662 00000 | WÄLZLAGER 6207 DIN 625 | |
| | 10 | 906576 00000 | WELLENDICHTRING | |
| | 11 | 912820 00000 | VERSCHLUSSDECKEL | |
| | 12 | 001101 26400 | LAGERDECKEL | |
| | 14 | 945319 00000 | INNENSECHSKANTSCHRAUBE | |
| | 15 | 000800 26400 | SEITENDECKEL MIT LATERNE | |
| | 16 | 000702 26400 | SEITENDECKEL | |
| 18 | 902108 00000 | GEBLÄSEKUPPLUNG, Ø28MM | | |
| 19 | 902210 00000 | KUPPLUNGSSSCHEIBE | | |
| 21 | 945331 00000 | INNENSECHSKANTSCHRAUBE | | |
| 22 | 948742 00000 | PASSKERBSTIFT | | |
| 24 | 947733 00000 | PASSFEDER | | |
| 30 | 502301 26400 | VENTILATOR MIT NABE | | |
| 31 | 947732 00000 | PASSFEDER | | |
| 32 | 945270 00000 | WELLENENDSCHRAUBE | | |
| 33 | 949409 00000 | UNTERLEGSSCHEIBE | | |
| 41 | 537502 26400 | RÜCKSCHLAGVENTIL, KOMPL. | | |
| 46 | 008002 26400 | SIEB | | |
| 47 | 945371 00000 | INNENSECHSKANTSCHRAUBE | | |
| 49 | 951602 00000 | RINGMUTTER | | |
| 50 | 946969 00000 | STIFTSCHRAUBE | | |
| 52 | 951228 00000 | VERSCHLUSS-SCHRAUBE | | |
| 61 | 002406 26400 | ABSCHIEDERGEHÄUSE | | |
| 62 | 951221 00100 | VERSCHLUSS-SCHRAUBE | | |
| 64 | 001703 26400 | ÖLBEHÄLTER-DECKEL | | |
| 67 | 003705 26400 | DECKEL | | |
| 69 | 946968 00000 | STIFTSCHRAUBE | | |
| 70 | 917107 00000 | TELLERFEDER | | |
| 71 | 947105 00000 | SECHSKANTMUTTER | | |
| 74 | 305800 02000 | ÜBERWURFMUTTER | | |
| 76 | 727505 99628 | ABBLASEVENTIL | | |
| 82 | 537502 26200 | VENTIL, KOMPL. | | |
| 83 | 965415 00000 | LUFTENTÖLEMENT (2x) ²⁾ | | |
| 89 | 921500 50000 | HANDGRIFF | | |
| 90 | 013300 26400 | PRALLBLECH | | |
| 91 | 945318 00000 | INNENSECHSKANTSCHRAUBE | | |
| 93 | 945226 00000 | SECHSKANTSCHRAUBE | | |
| 94 | 867800 99559 | SCHWIMMER | | |
| 95 | 003300 10700 | DÜSE | | |
| 98 | 912871 00000 | VERSCHLUSS-SCHRAUBE | | |
| 101 | 506000 26400 | GROBABSCHIEDER, KOMPLETT | | |
| 104 | 008003 26400 | SIEB | | |
| 105 | 952014 00000 | SPANNHÜLSE | | |
| 112 | 003703 26400 | DECKEL | | |
| 119 | 907309 00000 | ÖLSCHAUGLAS | | |
| 120 | 916800 10000 | SCHRAUBDECKEL | | |
| 124 | 947104 00000 | SECHSKANTMUTTER | | |
| 125 | 948504 00000 | FEDERING | | |
| 126 | 951001 02000 | STIFTSCHRAUBE | | |
| 128 | 951003 02000 | STIFTSCHRAUBE | | |
| 130 | 945383 00000 | INNENSECHSKANTSCHRAUBE | | |
| 131 | 945230 00000 | SECHSKANTSCHRAUBE | | |
| 132 | 945363 00000 | INNENSECHSKANTSCHRAUBE | | |

| G INDEX | Pos. | Bestell Nr. | Beschreibung |  |
|-------------------|---|--------------|--|--|
| | 133 | 945321 00000 | INNENSECHSKANTSCHRAUBE | |
| | 134 | 945324 00000 | INNENSECHSKANTSCHRAUBE | |
| | 135 | 951220 00100 | VERSCHLUSS-SCHRAUBE | |
| | 141 | 012219 26400 | LEITUNG | |
| | 143 | 012202 26400 | ÖLRÜCKFÜHRLEITUNG | |
| | 144 | 012216 26400 | LEITUNG | |
| | 148 | 948402 00000 | HOHLSCHRAUBE | |
| | 152 | 009400 19000 | KUGELSTÜCKSCHRAUBE | |
| | 154 | 012900 19000 | VERSCHLUSS-SCHRAUBE | |
| | 156 | 912306 00000 | ANSCHLUSS-SCHRAUBE | |
| | 157 | 960201 26400 | KÜHLER | |
| | 159 | 012214 26400 | LEITUNG | |
| | 181 | 018301 26400 | HAUBE | |
| | 184 | 945237 00000 | SECHSKANTSCHRAUBE | |
| | 185 | 947506 00000 | UNTERLEGSSCHEIBE | |
| | 187 | 568100 26400 | STÜTZE | |
| | 188 | 949408 00000 | U-SCHEIBE | |
| | 190 | 945227 00000 | WELLENABSCHLUSS-SCHRAUBE | |
| | 193 | 949203 00000 | ZAHNSCHEIBE | |
| | 197 | 741302 00000 | GUMMIPUFFER | |
| | 198 | 945634 00000 | GEWINDESTIFT | |
| | 214 | 950700 10000 | LÜSTERKLEMME | |
| | 215 | 946304 00000 | INNENSECHSKANTSCHRAUBE | |
| | 216 | 943400 90000 | TEMPERATURFÜHLER | |
| | 218 | 902108 00000 | MOTORKUPPLUNG, Ø28MM | |
| | 282 | 741103 99682 | NIVEAUGEBER - OPTIONAL | |
| | 313 | 902100 26300 | MOTORKUPPLUNG (US) | |
| | 314 | 945236 00000 | SECHSKANTSCHRAUBE (US) | |
| | 316 | 037900 12900 | ZWISCHENFLANSCH (US) | |
| | 406 | 768705 99626 | GASBALLASTVENTIL - OPTIONAL | |
| |  | 960009 00200 | BECKER LUBE M 100 (MINERALÖL) - 5L | |
| | | 960016 00200 | BECKER LUBE S 100 (SYNTHETIKÖL) - 5L | |
| | | 960023 00200 | BECKER LUBE SL 100 (LEBENSMITTELBEREICH) - 5L | |

¹⁾ Dichtungssatz - 549000 26400 - Pos.: 13, 25, 26, 44, 53, 63, 77, 79, 80, 118, 121, 129, 136, 149, 153, 283
²⁾ erforderliche Bestellmenge / Wartung

| G INDEX | Pos. | Ident No. | Description |  |
|------------|--------------|---|---|---|
| | | | | |
| U 4.165 | □ | 549000 26400 | SET OF SEALS ¹⁾ | |
| | 1 | 000102 26300 | PUMP BODY | |
| | 3 | 020000 26300 | ROTOR | |
| | 5 | 900505 00003 | ROTOR VANE IN PLASTIC (KIT) ²⁾ | |
| | 7 | 917611 00000 | BEARING SEALING WASHER | |
| | 8 | 911472 00000 | DISTANCE DISC | |
| | 9 | 906662 00000 | BEARING 6207 DIN 625 | |
| | 10 | 906576 00000 | SHAFT SEALING RING | |
| | 11 | 912820 00000 | CAP | |
| | 12 | 001101 26400 | BEARING COVER | |
| | 14 | 945319 00000 | SOCKET HEAD SCREW | |
| | 15 | 000800 26400 | LID WITH FLANGE | |
| | 16 | 000702 26400 | LID | |
| 18 | 902108 00000 | COUPLING PUMP, Ø28MM | | |
| 19 | 902210 00000 | COUPLING DISC | | |
| 21 | 945331 00000 | SOCKET HEAD SCREW | | |
| 22 | 948742 00000 | STRAIGHT PIN | | |
| 24 | 947733 00000 | KEY | | |
| 30 | 502301 26400 | FAN | | |
| 31 | 947732 00000 | KEY | | |
| 32 | 945270 00000 | SHAFT END BOLD | | |
| 33 | 949409 00000 | WASHER | | |
| 41 | 537502 26400 | NON RETURN VALVE, ENTIRE | | |
| 46 | 008002 26400 | SIEVE | | |
| 47 | 945371 00000 | SOCKET HEAD SCREW | | |
| 49 | 951602 00000 | RING UNIT | | |
| 50 | 946969 00000 | STUD | | |
| 52 | 951228 00000 | LOCKING SCREW | | |
| 61 | 002406 26400 | HOUSING FOR OIL SEPARATION | | |
| 62 | 951221 00100 | LOCKING SCREW | | |
| 64 | 001703 26400 | OIL TANK COVER | | |
| 67 | 003705 26400 | COVER | | |
| 69 | 946968 00000 | STUD | | |
| 70 | 917107 00000 | SPRING COLLAR | | |
| 71 | 947105 00000 | HEX.NUT | | |
| 74 | 305800 02000 | COUPLING NUT | | |
| 76 | 727505 99628 | BLOW OFF VALVE | | |
| 82 | 537502 26200 | VALVE, ENTIRE | | |
| 83 | 965415 00000 | OIL SEPARATION ELEMENT (2x) ²⁾ | | |
| 89 | 921500 50000 | HANDLE | | |
| 90 | 013300 26400 | METAL FILTER | | |
| 91 | 945318 00000 | SOCKET HEAD SCREW | | |
| 93 | 945226 00000 | HEX. HEAD SCREW | | |
| 94 | 867800 99559 | FLOAT | | |
| 95 | 003300 10700 | NOZZLE | | |
| 98 | 912871 00000 | LOCKING SCREW | | |
| 101 | 506000 26400 | COARSE SEPARATOR | | |
| 104 | 008003 26400 | SIEVE | | |
| 105 | 952014 00000 | FIXING SLEEVE | | |
| 112 | 003703 26400 | COVER | | |
| 119 | 907309 00000 | OIL SIGHT GLASS | | |
| 120 | 916800 10000 | COVER | | |
| 124 | 947104 00000 | HEX.NUT | | |
| 125 | 948504 00000 | SPRING WASHER | | |
| 126 | 951001 02000 | STUD | | |
| 128 | 951003 02000 | STUD | | |
| 130 | 945383 00000 | SOCKET HEAD SCREW | | |
| 131 | 945230 00000 | HEX-HEAD SCREW | | |
| 132 | 945363 00000 | SOCKET HEAD SCREW | | |

| G INDEX | Pos. | Ident No. | Description |  |
|------------|------|--|--|--|
| | | | | |
| | 133 | 945321 00000 | SOCKET HEAD SCREW | |
| | 134 | 945324 00000 | SOCKET HEAD SCREW | |
| | 135 | 951220 00100 | LOCKING SCREW | |
| | 141 | 012219 26400 | PIPE | |
| | 143 | 012202 26400 | OIL RETURN PIPE | |
| | 144 | 012216 26400 | PIPE | |
| | 148 | 948402 00000 | HOLLOW SCREW | |
| | 152 | 009400 19000 | HOLLOW HOLDING SCREW | |
| | 154 | 012900 19000 | LOCKING SCREW | |
| | 156 | 912306 00000 | CONNECTING SCREW | |
| | 157 | 960201 26400 | COOLER | |
| | 159 | 012214 26400 | PIPE | |
| | 181 | 018301 26400 | PROTECTING HOOD | |
| | 184 | 945237 00000 | HEX-HEAD SCREW | |
| | 185 | 947506 00000 | WASHER | |
| | 187 | 568100 26400 | SUPPORT PILLAR | |
| | 188 | 949408 00000 | WASHER | |
| | 190 | 945227 00000 | SCREW | |
| | 193 | 949203 00000 | TOOTHED SPRING WASHER | |
| | 197 | 741302 00000 | RUBBER BUFFER | |
| | 198 | 945634 00000 | THREADED PIN | |
| | 214 | 950700 10000 | LUSTER TERMINAL | |
| | 215 | 946304 00000 | SOCKET HEAD SCREW | |
| | 216 | 943400 90000 | TEMPERATURE PROBE | |
| | 218 | 902108 00000 | COUPLING MOTOR SIDE Ø28MM | |
| | 282 | 741103 99682 | OIL LEVEL CONTROL - OPTIONAL | |
| | 313 | 902100 26300 | COUPLING MOTOR SIDE (US) | |
| | 314 | 945236 00000 | HEX-HEAD SCREW (US) | |
| | 316 | 037900 12900 | FLANGES (US) | |
| | 406 | 768705 99626 | GAS BALLAST VALVE - OPTIONAL | |
| | |  960009 00200 | BECKER LUBE M 100 (MINERAL OIL) - 5L | |
| | | 960016 00200 | BECKER LUBE S 100 (SYNTHETIC OIL) - 5L | |
| | | 960023 00200 | BECKER LUBE SL 100 (FOOD SECTOR) - 5L | |

¹⁾ Set of seals - 549000 26400 - Pos.: 13, 25, 26, 44, 53, 63, 77, 79, 80, 118, 121, 129, 136, 149, 153, 283
²⁾ necessary order quantity / maintenance

| G INDICE | Pos. | No. Identification | Designation | FR | |
|-------------|--------------|---|--|----|--|
| | | | | | |
| U 4.165 | ■ | 549000 26400 | JEU DE JOINTS ¹⁾ | | |
| | 1 | 000102 26300 | CORP DE POMPE | | |
| | 3 | 020000 26300 | PISTON | | |
| | 5 | 900505 00003 | PALETTE ON PLASTIQUE (KIT) ²⁾ | | |
| | 7 | 917611 00000 | RONDELLE D'ETANCHEITE DU ROULEMENT | | |
| | 8 | 911472 00000 | DISQUE AJUSTAGE | | |
| | 9 | 906662 00000 | ROULEMENT 6207 DIN 625 | | |
| | 10 | 906576 00000 | BAGUE D'ETANCHEITE P.L'AXE | | |
| | 11 | 912820 00000 | COUVERCLE | | |
| | 12 | 001101 26400 | COUVERCLE DE ROULEMENTE | | |
| | 14 | 945319 00000 | VIS HEXAGONALE INTERNE | | |
| | 15 | 000800 26400 | COUVERCLE AVEC BRIDE | | |
| | 16 | 000702 26400 | COUVERCLE | | |
| 18 | 902108 00000 | ACCOUPLLEMENT POMPE, Ø28MM | | | |
| 19 | 902210 00000 | DISQUE D'ACCOUPLLEMENT | | | |
| 21 | 945331 00000 | VIS HEXAGONALE INTERNE | | | |
| 22 | 948742 00000 | GOUPILLE CYLINDRIQUE | | | |
| 24 | 947733 00000 | CLAVETTE | | | |
| 30 | 502301 26400 | VENTILATEUR | | | |
| 31 | 947732 00000 | CLAVETTE | | | |
| 32 | 945270 00000 | VIS BOUT D'ARBRE | | | |
| 33 | 949409 00000 | RONDELLE | | | |
| 41 | 537502 26400 | SOUPAPE ANTI-RETOUR, ENTIER | | | |
| 46 | 008002 26400 | FILTRE | | | |
| 47 | 945371 00000 | VIS HEXAGONALE INTERNE | | | |
| 49 | 951602 00000 | ECROU A ANNEAU | | | |
| 50 | 946969 00000 | PRISONNIER | | | |
| 52 | 951228 00000 | BOUCHON | | | |
| 61 | 002406 26400 | CORP DE SEPARATEUR D'HUILE | | | |
| 62 | 951221 00100 | BOUCHON | | | |
| 64 | 001703 26400 | COUVERCLE RESERVOIR D'HUILE | | | |
| 67 | 003705 26400 | COUVERCLE | | | |
| 69 | 946968 00000 | PRISONNIER | | | |
| 70 | 917107 00000 | RONDELLE À RESSORT | | | |
| 71 | 947105 00000 | ECROU A 6 PANS | | | |
| 74 | 305800 02000 | ECROU | | | |
| 76 | 727505 99628 | SILENCIEUX | | | |
| 82 | 537502 26200 | SOUPAPE, ENTIER | | | |
| 83 | 965415 00000 | ELEMENT SEPARATION HUILE (2x) ²⁾ | | | |
| 89 | 921500 50000 | POIGNEE | | | |
| 90 | 013300 26400 | FILTRE METALIQUE | | | |
| 91 | 945318 00000 | VIS HEXAGONALE INTERNE | | | |
| 93 | 945226 00000 | VIS HEXAGONALE | | | |
| 94 | 867800 99559 | PIED CAOUTCHOVE | | | |
| 95 | 003300 10700 | GICLEUR | | | |
| 98 | 912871 00000 | BOUCHON | | | |
| 101 | 506000 26400 | SEPARATEUR A GROS | | | |
| 104 | 008003 26400 | FILTRE | | | |
| 105 | 952014 00000 | MANCHON DE FIXATION | | | |
| 112 | 003703 26400 | COUVERCLE | | | |
| 119 | 907309 00000 | VERRE REGARD | | | |
| 120 | 916800 10000 | COUVERCLE | | | |
| 124 | 947104 00000 | ECROU A 6PANS | | | |
| 125 | 948504 00000 | ANNEAU-RESSORT | | | |
| 126 | 951001 02000 | PRISONNIER | | | |
| 128 | 951003 02000 | PRISONNIER | | | |
| 130 | 945383 00000 | VIS HEXAGONALE INTERNE | | | |
| 131 | 945230 00000 | VIS HEXAGONALE | | | |
| 132 | 945363 00000 | VIS HEXAGONALE INTERNE | | | |

| G INDICE | Pos. | No. Identification | Designation | FR | |
|---|------|--|--|----|--|
| | | | | | |
| | 133 | 945321 00000 | VIS HEXAGONALE INTERNE | | |
| | 134 | 945324 00000 | VIS HEXAGONALE INTERNE | | |
| | 135 | 951220 00100 | BOUCHON | | |
| | 141 | 012219 26400 | TUYAU | | |
| | 143 | 012202 26400 | TUYAU D'HUILE | | |
| | 144 | 012216 26400 | TUYAU | | |
| | 148 | 948402 00000 | VIS CREUSE | | |
| | 152 | 009400 19000 | VIS CREUSE DE FIXATION | | |
| | 154 | 012900 19000 | BUCHON | | |
| | 156 | 912306 00000 | VIS DE RACCORD | | |
| | 157 | 960201 26400 | REFROIDISSEUR | | |
| | 159 | 012214 26400 | TUYAU | | |
| | 181 | 018301 26400 | CARTER PROTECTEUR | | |
| | 184 | 945237 00000 | VIS HEXAGONALE | | |
| | 185 | 947506 00000 | RONDELLE | | |
| | 187 | 568100 26400 | SUPPORT INTERMEDIAIRE | | |
| | 188 | 949408 00000 | RONDELLE | | |
| | 190 | 945227 00000 | VIS | | |
| | 193 | 949203 00000 | DENT DISQUE | | |
| | 197 | 741302 00000 | AMORTISSEUR EN CAOUTCHOUC | | |
| | 198 | 945634 00000 | GOUPILLE FILETEE | | |
| | 214 | 950700 10000 | SERRE-FILS | | |
| | 215 | 946304 00000 | VIS HEXAGONALE INTERNE | | |
| | 216 | 943400 90000 | PALPEUR DE TEMPERATURE | | |
| | 218 | 902108 00000 | ACCOUPLLEMENT MOTEUR Ø28MM | | |
| | 282 | 741103 99682 | INDICATEUR DE NIVEAU - EN OPTION | | |
| | 313 | 902100 26300 | ACCOUPLLEMENT MOTEUR (US) | | |
| | 314 | 945236 00000 | VIS HEXAGONALE (US) | | |
| | 316 | 037900 12900 | BRIDES (US) | | |
| | 406 | 768705 99626 | L'ESTE D'AIR - EN OPTION | | |
| | |  960009 00200 | BECKER LUBE M 100 (HUILE MINÉRALE) - 5L | | |
| | | 960016 00200 | BECKER LUBE S 100 (L'HUILE SYNTHÉTIQUE) - 5L | | |
| | | 960023 00200 | BECKER LUBE SL 100 (SECTEUR DE L'ALIMENTATION) - 5L | | |
| ¹⁾ Jeu de joints - 549000 26400 - Pos.: 13, 25, 26, 44, 53, 63, 77, 79, 80, 118, 121, 129, 136, 149, 153, 283 ²⁾ quantité nécessaire / entretien | | | | | |

| G INDICE | Pos. | No. Identificazione | Designazione | IT | |
|-------------|--------------|---|--|----|--|
| | | | | | |
| U 4.165 | □ | 549000 26400 | SERIE DI GUARNIZIONE ¹⁾ | | |
| | 1 | 000102 26300 | CARCASSA | | |
| | 3 | 020000 26300 | ROTORE | | |
| | 5 | 900505 00003 | PALETTE IN PLASTICA (KIT) ²⁾ | | |
| | 7 | 917611 00000 | ANELLO DI TENUTA DEL CUSCINETTO | | |
| | 8 | 911472 00000 | DISCO DISTANZA | | |
| | 9 | 906662 00000 | CUSCINETTO 6207 DIN 625 | | |
| | 10 | 906576 00000 | GUARNIZIONE PER L'ALBERO | | |
| | 11 | 912820 00000 | COPERCHIO | | |
| | 12 | 001101 26400 | COPERCHIO CUSCINETTO | | |
| | 14 | 945319 00000 | VITE ESAGONALE INTERNA | | |
| | 15 | 000800 26400 | COPERCHIO CON FLANGIA | | |
| | 16 | 000702 26400 | COPERCHIO | | |
| 18 | 902108 00000 | GIUNTO POMPA, Ø28MM | | | |
| 19 | 902210 00000 | DISCO GUIUNTO | | | |
| 21 | 945331 00000 | VITE ESAGONALE INTERNA | | | |
| 22 | 948742 00000 | PERNO | | | |
| 24 | 947733 00000 | CHIAVETTA | | | |
| 30 | 502301 26400 | VENTILATORE | | | |
| 31 | 947732 00000 | CHIAVETTA | | | |
| 32 | 945270 00000 | VITE DI CHIUSURA ALBERO | | | |
| 33 | 949409 00000 | RONDELLA | | | |
| 41 | 537502 26400 | VALVOLA NON RITORNO, INTERO | | | |
| 46 | 008002 26400 | FILTRO | | | |
| 47 | 945371 00000 | VITE ESAGONALE INTERNA | | | |
| 49 | 951602 00000 | GOLFARE CON FORO FILETTATO | | | |
| 50 | 946969 00000 | L'ASTA A VITE | | | |
| 52 | 951228 00000 | VITE DI CHIUSURA | | | |
| 61 | 002406 26400 | CARCASSA SEPARATORE OLIO | | | |
| 62 | 951221 00100 | VITE DI CHIUSURA | | | |
| 64 | 001703 26400 | COPERCHIO SERBATOIO OLIO | | | |
| 67 | 003705 26400 | COPERCHIO | | | |
| 69 | 946968 00000 | L'ASTA A VITE | | | |
| 70 | 917107 00000 | RONDELLA A MOLLA | | | |
| 71 | 947105 00000 | DADO ESAGONALE | | | |
| 74 | 305800 02000 | DADO DI RISVOLTO | | | |
| 76 | 727505 99628 | SILENZIATORE | | | |
| 82 | 537502 26200 | VALVOLA, INTERO | | | |
| 83 | 965415 00000 | CARTUCCIA SEPARATORE OLIO (2x) ²⁾ | | | |
| 89 | 921500 50000 | MANETTA | | | |
| 90 | 013300 26400 | FILTRO METALICO | | | |
| 91 | 945318 00000 | VITE ESAGONALE INTERNA | | | |
| 93 | 945226 00000 | VITE ESAGONALE | | | |
| 94 | 867800 99559 | GALLEGGIANTE | | | |
| 95 | 003300 10700 | UGELLO | | | |
| 98 | 912871 00000 | VITE DI CHIUSURA | | | |
| 101 | 506000 26400 | SEPARATORE GROSSOLANO | | | |
| 104 | 008003 26400 | FILTRO | | | |
| 105 | 952014 00000 | MANICOTTO DI FISSAZIONE | | | |
| 112 | 003703 26400 | COPERCHIO | | | |
| 119 | 907309 00000 | SPIA LIVELLO OLIO | | | |
| 120 | 916800 10000 | COPERCHIO | | | |
| 124 | 947104 00000 | DADO ESAGONALE | | | |
| 125 | 948504 00000 | ANELLO A MOLLA | | | |
| 126 | 951001 02000 | L'ASTA A VITE | | | |
| 128 | 951003 02000 | L'ASTA A VITE | | | |
| 130 | 945383 00000 | VITE ESAGONALE INTERNA | | | |
| 131 | 945230 00000 | VITE ESAGONALE | | | |
| 132 | 945363 00000 | VITE ESAGONALE INTERNA | | | |

| G INDICE | Pos. | No. Identificazione | Designazione | IT | |
|-------------|------|--|---|----|--|
| | | | | | |
| | 133 | 945321 00000 | VITE ESAGONALE INTERNA | | |
| | 134 | 945324 00000 | VITE ESAGONALE INTERNA | | |
| | 135 | 951220 00100 | VITE DI CHIUSURA | | |
| | 141 | 012219 26400 | CONDOTTO | | |
| | 143 | 012202 26400 | CONDOTTO OLIO | | |
| | 144 | 012216 26400 | CONDOTTO | | |
| | 148 | 948402 00000 | VITE ESAGONALE | | |
| | 152 | 009400 19000 | VITE PASSAGGIO OLIO | | |
| | 154 | 012900 19000 | VITE DI CHIUSURA | | |
| | 156 | 912306 00000 | ATTACO FILETTATO | | |
| | 157 | 960201 26400 | RAFFREDDATORE | | |
| | 159 | 012214 26400 | CONDOTTO | | |
| | 181 | 018301 26400 | CARTER DI PROTEZIONE | | |
| | 184 | 945237 00000 | VITE ESAGONALE | | |
| | 185 | 947506 00000 | RONDELLA | | |
| | 187 | 568100 26400 | SUPPORTO | | |
| | 188 | 949408 00000 | RONDELLA | | |
| | 190 | 945227 00000 | VITE | | |
| | 193 | 949203 00000 | DISCO A DENTE | | |
| | 197 | 741302 00000 | AMMORTIZZATORE IN GOMMA | | |
| | 198 | 945634 00000 | SPINA FILETTATURA | | |
| | 214 | 950700 10000 | SCATOLA DEI CONNETTORI | | |
| | 215 | 946304 00000 | VITE ESAGONALE INTERNA | | |
| | 216 | 943400 90000 | TASTATORE TEMPERATURE | | |
| | 218 | 902108 00000 | GIUNTO MOTORE Ø28MM | | |
| | 282 | 741103 99682 | SONDA D'OLIO - OPTIONALE | | |
| | 313 | 902100 26300 | GUIUNTO MOTORE (US) | | |
| | 314 | 945236 00000 | VITE ESAGONALE (US) | | |
| | 316 | 037900 12900 | FLANGE (US) | | |
| | 406 | 768705 99626 | VALVOLA DI ZAVORATRICE - OPTIONALE | | |
| | |  960009 00200 | BECKER LUBE M 100 (OLIO MINERALE) - 5L | | |
| | | 960016 00200 | BECKER LUBE S 100 (OLIO SINTETICO) - 5L | | |
| | | 960023 00200 | BECKER LUBE SL 100 (SETTORE ALIMENTARE) - 5L | | |

¹⁾ Serie di guarnizione - 549000 26400 - Pos.: 13, 25, 26, 44, 53, 63, 77, 79, 80, 118, 121, 129, 136, 149, 153, 283







²⁾ quantità di ordinazione necessari / manutenzione

| G INDICE | Pos. | No. De pedido | Descripción | ES | |
|-------------|--------------|--|--|----|--|
| | | | | ES | |
| U 4.165 | □ | 549000 26400 | JUNTA COMPLETA ¹⁾ | | |
| | 1 | 000102 26300 | CARCASA | | |
| | 3 | 020000 26300 | ÉMBOLO | | |
| | 5 | 900505 00003 | EMPUJADOR DE PLÁSTICO (KIT) ²⁾ | | |
| | 7 | 917611 00000 | ANILLO DE COJINETE DE JUNTA | | |
| | 8 | 911472 00000 | ARANDELA DISTANCIADORA | | |
| | 9 | 906662 00000 | COJINETE DE RODAMIENTO 6207 DIN 625 | | |
| | 10 | 906576 00000 | ANILLO DE JUNTA DE ÁRBOL | | |
| | 11 | 912820 00000 | TAPA DE CIERRE | | |
| | 12 | 001101 26400 | TAPA LATERAL | | |
| | 14 | 945319 00000 | TAPA LATERAL | | |
| | 15 | 000800 26400 | TAPA LATERAL CON FAROL | | |
| | 16 | 000702 26400 | DISCO DE ACOPLAMIENTO | | |
| 18 | 902108 00000 | TORNILLO HEXAGONAL INTERIOR | | | |
| 19 | 902210 00000 | PASADOR ENTALLADO DE AJUSTE | | | |
| 21 | 945331 00000 | LENGÜETA DE AJUSTE | | | |
| 22 | 948742 00000 | VENTILADOR CON CUBO | | | |
| 24 | 947733 00000 | LENGÜETA DE AJUSTE | | | |
| 30 | 502301 26400 | TORNILLO TERMINAL DE ÁRBOL | | | |
| 31 | 947732 00000 | ARANDELA | | | |
| 32 | 945270 00000 | FAROL | | | |
| 33 | 949409 00000 | TORNILLO HEXAGONAL INTERIOR | | | |
| 41 | 537502 26400 | VÁLVULA ANTIRRETORNO COMPLETA | | | |
| 46 | 008002 26400 | CRIBA | | | |
| 47 | 945371 00000 | TORNILLO HEXAGONAL INTERIOR | | | |
| 49 | 951602 00000 | TUERCA DE CÁNCAMO | | | |
| 50 | 946969 00000 | ESPÁRRAGO | | | |
| 52 | 951228 00000 | TORNILLO DE CIERRE | | | |
| 61 | 002406 26400 | CARCASA SEPARADORA | | | |
| 62 | 951221 00100 | TORNILLO DE CIERRE | | | |
| 64 | 001703 26400 | TAPA DE RECIPIENTE DE ACEITE | | | |
| 67 | 003705 26400 | TAPA | | | |
| 69 | 946968 00000 | ESPÁRRAGO | | | |
| 70 | 917107 00000 | ARANDELA DE APOYO DEL RESORTE | | | |
| 71 | 947105 00000 | TUERCA HEXAGONAL | | | |
| 74 | 305800 02000 | SOBRETUERCA | | | |
| 76 | 727505 99628 | VÁLVULA DE BARRIDO | | | |
| 82 | 537502 26200 | VÁLVULA COMPLETA | | | |
| 83 | 965415 00000 | ELEMENTO DE DESACEITAR DE AIRE (2x) ²⁾ | | | |
| 89 | 921500 50000 | EMPUÑADURA | | | |
| 90 | 013300 26400 | CHAPA DE REBOTE | | | |
| 91 | 945318 00000 | TORNILLO HEXAGONAL INTERIOR | | | |
| 93 | 945226 00000 | TORNILLO DE CABEZA HEXAGONAL | | | |
| 94 | 867800 99559 | FLOTADOR | | | |
| 95 | 003300 10700 | TOBERA | | | |
| 98 | 912871 00000 | TORNILLO DE CIERRE | | | |
| 101 | 506000 26400 | SEPARADOR DE SÓLIDOS GRUESOS COMPLETO | | | |
| 104 | 008003 26400 | CRIBA | | | |
| 105 | 952014 00000 | MANGUITO DE FIJACIÓN | | | |
| 112 | 003703 26400 | TAPA | | | |
| 119 | 907309 00000 | CRISTAL MIRILLA DE ACEITE | | | |
| 120 | 916800 10000 | TAPA ROSCADA | | | |
| 124 | 947104 00000 | TUERCA HEXAGONAL | | | |
| 125 | 948504 00000 | ARANDELA DE MUELLE | | | |
| 126 | 951001 02000 | ESPÁRRAGO | | | |
| 128 | 951003 02000 | ESPÁRRAGO | | | |
| 130 | 945383 00000 | TORNILLO HEXAGONAL INTERIOR | | | |
| 131 | 945230 00000 | TORNILLO HEXAGONAL | | | |
| 132 | 945363 00000 | TORNILLO HEXAGONAL INTERIOR | | | |

| G INDICE | Pos. | No. De pedido | Descripción | ES | |
|---|------|--|---|----|--|
| | | | | ES | |
| | 133 | 945321 00000 | TORNILLO HEXAGONAL INTERIOR | | |
| | 134 | 945324 00000 | TORNILLO HEXAGONAL INTERIOR | | |
| | 135 | 951220 00100 | TORNILLO DE CIERRE | | |
| | 141 | 012219 26400 | CONDUCTO | | |
| | 143 | 012202 26400 | CONDUCTO DE RETROALIMENTACIÓN DE ACEITE | | |
| | 144 | 012216 26400 | CONDUCTO | | |
| | 148 | 948402 00000 | TORNILLO HUECO | | |
| | 152 | 009400 19000 | TORNILLO DE PIEZA ESFÉRICA | | |
| | 154 | 012900 19000 | TORNILLO DE CIERRE | | |
| | 156 | 912306 00000 | TORNILLO DE EMPALME | | |
| | 157 | 960201 26400 | REFRIGERADOR | | |
| | 159 | 012214 26400 | CONDUCTO | | |
| | 181 | 018301 26400 | SOMBRETERE | | |
| | 184 | 945237 00000 | TORNILLO DE CABEZA HEXAGONAL | | |
| | 185 | 947506 00000 | ARANDELA | | |
| | 187 | 568100 26400 | APOYO | | |
| | 188 | 949408 00000 | ARANDELA | | |
| | 190 | 945227 00000 | TORNILLO TERMINAL DE ÁRBOL | | |
| | 193 | 949203 00000 | POLEA DENTADA | | |
| | 197 | 741302 00000 | AMORTIGUADOR DE GOMA | | |
| | 198 | 945634 00000 | VARILLA ROSCADA | | |
| | 214 | 950700 10000 | CAJA DE CONEXIÓN | | |
| | 215 | 946304 00000 | TORNILLO HEXAGONAL INTERIOR | | |
| | 216 | 943400 90000 | SENSOR DE TEMPERATURA | | |
| | 218 | 902108 00000 | ACOPLAMIENTO DE MOTOR Ø38MM | | |
| | 282 | 741103 99682 | GENERADOR DE NIVEL - OPCIONAL | | |
| | 313 | 902100 26300 | ACOPLAMIENTO DE MOTOR (US) | | |
| | 314 | 945236 00000 | TORNILLO DE CABEZA HEXAGONAL (US) | | |
| | 316 | 037900 12900 | BRIDA INTERMEDIA (US) | | |
| | 406 | 768705 99626 | VÁLVULA DE LASTRE DE GAS - OPCIONAL | | |
| | |  960009 00200 | BECKER LUBE M 100 (ACEITE MINERAL) - 5L | | |
| | | 960016 00200 | BECKER LUBE S 100 (ACEITE SINTÉTICO) - 5L | | |
| | | 960023 00200 | BECKER LUBE SL 100 (SECTOR ALIMENTARIO) - 5L | | |
| ¹⁾ Junta completa - 549000 26400 - Pos.: 13, 25, 26, 44, 53, 63, 77, 79, 80, 118, 121, 129, 136, 149, 153, 283 ²⁾ cantidad necesario / mantenimiento | | | | | |

| U 4.165 | Variante | Pos. ²⁾ | Bestell Nr. / Ident No. / No. Identification / No. Identificazione / No. De pedido | | Beschreibung / Description / Designation / Designazione / Desripcion | |
|---|--------------|--------------------|---|---|---|--|
| | | | | | | |
| ① U 4.165 F/K | | 97 | 912300 00000 | | ANSCHLUSSSCHRAUBE / CONNECTING SCREW / VIS DE RACCORD / ATTACO FILETTATO / TORNILLO DE EMPALME | |
| | | 98 | | 912871-00000 | VERSCHLUSSSCHRAUBE / LOCKING SCREW / BOUCHON / VITE DI CHIUSURA / TORNILLO DE CIERRE | |
| | | 151 | 012220 26400 | | LEITUNG / OIL SUCTION PIPE / TUYAU D'HUILE / CONDOTTO OLIO / CONDUCTO DE ASPIRACIÓN DE ACEITE | |
| | | 152 | 009400 19000 | | KUGELSTÜCKSCHRAUBE / HOLLOW HOLDING SCREW / VIS CREUSE DE FIXATION / VITE PASSAGGIO OLIO / TORNILLO DE PIEZA ESFÉRICA | |
| | | 153 | 948002 00000 | | DICHTUNG / GASKET / JOINT / GUARNIZIONE / JUNTA | |
| | | 154 | | 012900-19000 | VERSCHLUSSSCHRAUBE / LOCKING SCREW / BOUCHON / VITE DI CHIUSURA / TORNILLO DE CIERRE | |
| | | 233 | 537503 26400 | | VENTIL, KOMPL. / VALVE, ENTIRE / SOUPAPE, ENTIER / VALVOLA, INTERO / VÁLVULA COMPLETA | |
| ② U 4.165 SA/K-25 ③ U 4.165 F/K-25 - mit Öl-Wasser-Kühler - with oil-to-water heat exchanger - avec réfrigérant à l'huile et à l'eau - con radiatore ad olio - acqua - con refrigerador aceite-agua | | 91 | | 945318-00000 | INNENSECHSKANTSCHRAUBE / ALLEN SCREW / VIS ALLEN / VITE ESAGONALE INTERNA / TORNILLO HEXAGONAL INTERIOR | |
| | | 141 | 012210 26400 | | 012215-26400 | LEITUNG / PIPE / TUYAU / CONDOTTO / CONDUCTO |
| | | 142 | 012211 26400 | | | LEITUNG / PIPE / TUYAU / CONDOTTO / CONDUCTO |
| | | 144 | | 012216-26400 | | LEITUNG / PIPE / TUYAU / CONDOTTO / CONDUCTO |
| | | 145 | 012213 26400 | | | LEITUNG / PIPE / TUYAU / CONDOTTO / CONDUCTO |
| | | 146 | 012212 26300 | | | LEITUNG / PIPE / TUYAU / CONDOTTO / CONDUCTO |
| | | 156 | 912301 00000 | | 912306-00000 | ANSCHLUSSSCHRAUBE / CONNECTING SCREW / VIS DE RACCORD / ATTACO FILETTATO / TORNILLO DE EMPALME |
| | | 157 | | 960201-26400 | | KUEHLER / COOLER / REFROIDISSEUR / RAFFREDDATORE / REFRIGERADOR |
| | | 159 | | 012214 26400 | | LEITUNG / PIPE / TUYAU / CONDOTTO / CONDUCTO |
| | | 181 | 018304 26400 | | 018301-26400 | HAUBE / PROTECTING HOOD / CARTER PROTECTEUR / CARTER DI PROTEZIONE / SOMBRERETE |
| | | 193 | | 949203-00000 | | ZAHNSCHEIBE / TOOTHED LOCK WASHER / RONDELLE À DENTS / RONDELLA DENTATA / ARANDELA DENTADA |
| | | 203 | 960204 26200 | | | KÜHLER / COOLER / REFROIDISSEUR / RAFFREDDATORE / REFRIGERADOR |
| | | 204 | 969438 00000 | | | L-VERSCHRÄUBUNG / L-PIECE / L-PIECE / PEZZO A L / ATORNILLADURA |
| | | 205 | 935200 10000 | | | VERLÄNGERUNG / ADAPTOR / RACCORD INTERMÉDIAIRE / RACCORDO INTERMEDIO / ADAPTADOR |
| 206 | 969401 00009 | | | SCHLAUCH / FLEXIBLE HOSE / TUYAUTERIE FLEXIBLE / TUBAZIONE FLESSIBILE / TUBERÍA FLEXIBLE | | |
| 209 | 922401 20000 | | | SCHUTZGITTER / SAFETY GUARD / GRILLAGE DE PROTECTION / GABBIA DI PROTEZIONE / REJILLA DE PROTECCIÓN | | |
| ④ U 4.165 SA/K-25.1 ⑤ U 4.165 F/K-25.1 - mit Öl-Wasser-Kühler - with oil-to-water heat exchanger - avec réfrigérant à l'huile et à l'eau - con radiatore ad olio - acqua - con refrigerador aceite-agua | | 141 | 012217 26400 | | 012215-26400 | LEITUNG / PIPE / TUYAU / CONDOTTO / CONDUCTO |
| | | 142 | 012211 26400 | | | LEITUNG / PIPE / TUYAU / CONDOTTO / CONDUCTO |
| | | 145 | 012212 26400 | | | LEITUNG / PIPE / TUYAU / CONDOTTO / CONDUCTO |
| | | 146 | 012213 26400 | | | LEITUNG / PIPE / TUYAU / CONDOTTO / CONDUCTO |
| | | 181 | 018304 26400 | | 018301-26400 | HAUBE / PROTECTING HOOD / CARTER PROTECTEUR / CARTER DI PROTEZIONE / SOMBRERETE |
| | | 203 | 960204 26200 | | | KÜHLER / COOLER / REFROIDISSEUR / RAFFREDDATORE / REFRIGERADOR |
| | | 204 | 969438 00000 | | | L-VERSCHRÄUBUNG / L-PIECE / L-PIECE / PEZZO A L / ATORNILLADURA |
| | | 205 | 935200 10000 | | | VERLÄNGERUNG / ADAPTOR / RACCORD INTERMÉDIAIRE / RACCORDO INTERMEDIO / ADAPTADOR |
| 206 | 969401 00009 | | | SCHLAUCH / FLEXIBLE HOSE / TUYAUTERIE FLEXIBLE / TUBAZIONE FLESSIBILE / TUBERÍA FLEXIBLE | | |

²⁾ variantenabhängige Bauteile / variant-dependent components / composants variante-dependantes / componenti variante-dispendenti / componentes variante-dependientes

| U 4.165 | Variante  | Pos. ²⁾ | Bestell Nr. / Ident No. / No. Identification / No. Identificazione / No. De pedido | | Beschreibung / Description / Designation / Designazione / Desripcion | |
|--|---|--------------------|---|---|--|--|
| | | |    |    | | |
| ⑥ U 4.165 SA/K-51 ⑦ U 4.165 F/K-51 - mit Ölbadheizung, Niveau-Geber und Thermostat - with oil bath heating, level transmitter and heat valve - avec chauffage du bain d'huile, capteur de niveau et thermostat - con riscaldamento a bagno d'olio, indicatore di livello e termostato - con calefacción de baño de aceite, codificador de nivel y termostato | | 61 | | 002406 26400 | ÖLABSCHEIDERGEHÄUSE / HOUSING FOR OIL SEPARATION / CARCASSE POUR SEPARATION D'HUILLE / CARCASSA SEPARATORE OLIO / CARCASA SEPARADORA DE ACEITE | |
| | | 62 | | 951221 00100 | VERSCHLUSSSCHRAUBE / LOCKING SCREW / BOUCHON / VITE DI CHIUSURA / TORNILLO DE CIERRE | |
| | | 282 | 741103 99682 | | | NIVEAUGEBER / LEVEL TRANSMITTER / CAPTEUR DE NIVEAU / INDICATORE DI LIVELLO / CODIFICADOR DE NIVEL |
| | | 283 | 948086 00000 | | | DICHTRING / SEALING RING / JOINT / ANELLO / ANILLO |
| | | 340 | 002408 26400 | | | ÖLABSCHEIDERGEHÄUSE / HOUSING FOR OIL SEPARATION / CARCASSE POUR SEPARATION D'HUILLE / CARCASSA SEPARATORE OLIO / CARCASA SEPARADORA DE ACEITE |
| | | 341 | 960202 26400 | | | ROHRHEIZKÖRPER / PIPE HEATER / CORPS DE CHAUFFE / SCALDIGLIA / CALEFACTOR TUBULAR |
| | | 342 | 943400 70000 | | | TEMPERATUR-WÄCHTER / THERMOSTAT / THERMOSTAT / INTERRUPTORE TERMICO / TERMOSTATO |
| | | 343 | 948070 00000 | | | KUPFERRING / SEALING RING / JOINT / ANELLO / ANILLO DE COBRE |
| | | 344 | 913116 00100 | | | O-RING / O-RING SEAL / JOINT TORIQUE / GIUNTO CILINDRICO DI TENUTA / JUNTA TOROIDAL |
| | | 345 | 948011 00000 | | | DICHTRING / SEALING RING / JOINT / ANELLO / ANILLO |
| ⑧ U 4.165 SA/K-54 - mit zusätzlicher Ölablassbohrung - with additional oil draining bore hole - avec trou de vidange d'huile - con foro di scarico dell'olio aggiuntivo - con perforación de salida de aceite adicional | | 61 | | 002406 26400 | ÖLABSCHEIDERGEHÄUSE / HOUSING FOR OIL SEPARATION / CARCASSE POUR SEPARATION D'HUILLE / CARCASSA SEPARATORE OLIO / CARCASA SEPARADORA DE ACEITE | |
| | | 361 | 002407 26400 | | | ÖLABSCHEIDERGEHÄUSE / HOUSING FOR OIL SEPARATION / CARCASSE POUR SEPARATION D'HUILLE / CARCASSA SEPARATORE OLIO / CARCASA SEPARADORA DE ACEITE |
| | | 363 | 951220 00100 | | | VERSCHLUSSSCHRAUBE / LOCKING SCREW / BOUCHON / VITE DI CHIUSURA / TORNILLO DE CIERRE |

²⁾ variantenabhängige Bauteile / variant-dependent components / composants variante-dependantes / componenti variante-dispendenti / componentes variante-dependientes